



RUBIK Pi 3 V01 Datasheet

Revision: V1.1

Date: Mar 14, 2025



Revision History

Revision	Date	Description
1.0	Dec 09, 2024	Initial release.
1.1	Mar 14, 2025	<ul style="list-style-type: none">• Added Figure 3-1 and Appendix 1.• Updated Table 3-1.• Added Debian 12 to the OS support.• Updated all RUBIK Pi 3 V01 figures to RUBIK Pi 3 V02.• Changed the operating temperature to -20°C – 70°C.• Updated definitions of the 40-pin LS connector.



Table of Contents

Chapter 1. Overview	1
Chapter 2. Features	3
2.1. System block diagram	3
2.2. Component locations	4
2.3. Electrical characteristics	4
2.3.1. Power supply requirements	4
2.3.2. Output power requirements	5
2.4. Mechanical specification	6
Chapter 3. Expansion Connections	7
3.1. 40-pin LS connector	7
3.2. HDMI connector	8
3.3. Ethernet connector	8
3.4. USB connector	9
3.4.1. USB 3.1 Gen1 Type-C	9
3.4.2. USB 3.0 Type-A	9
3.4.3. USB 2.0 Type-A	9
3.5. 3.5mm audio connector	10
3.6. Camera connector	10
3.7. M.2 connector	12
3.8. Wi-Fi	13
3.9. Bluetooth	14
3.10. Fan connector	14
3.11. RTC battery connector	15
3.12. Micro USB to UART for debug	15
3.13. Buttons	16
3.13.1. Power on button	16
3.13.2. EDL button	16
3.14. LED	16
3.14.1. Power indicator LED	16
3.14.2. RGB LED	16
Chapter 4. Precautions	17
4.1. Operating environment	17
4.2. ESD prevention	17
4.3. Warning	17
4.4. Safety instructions	17
Appendix 1. Compliance and Certificate Information	18

Chapter 1. Overview

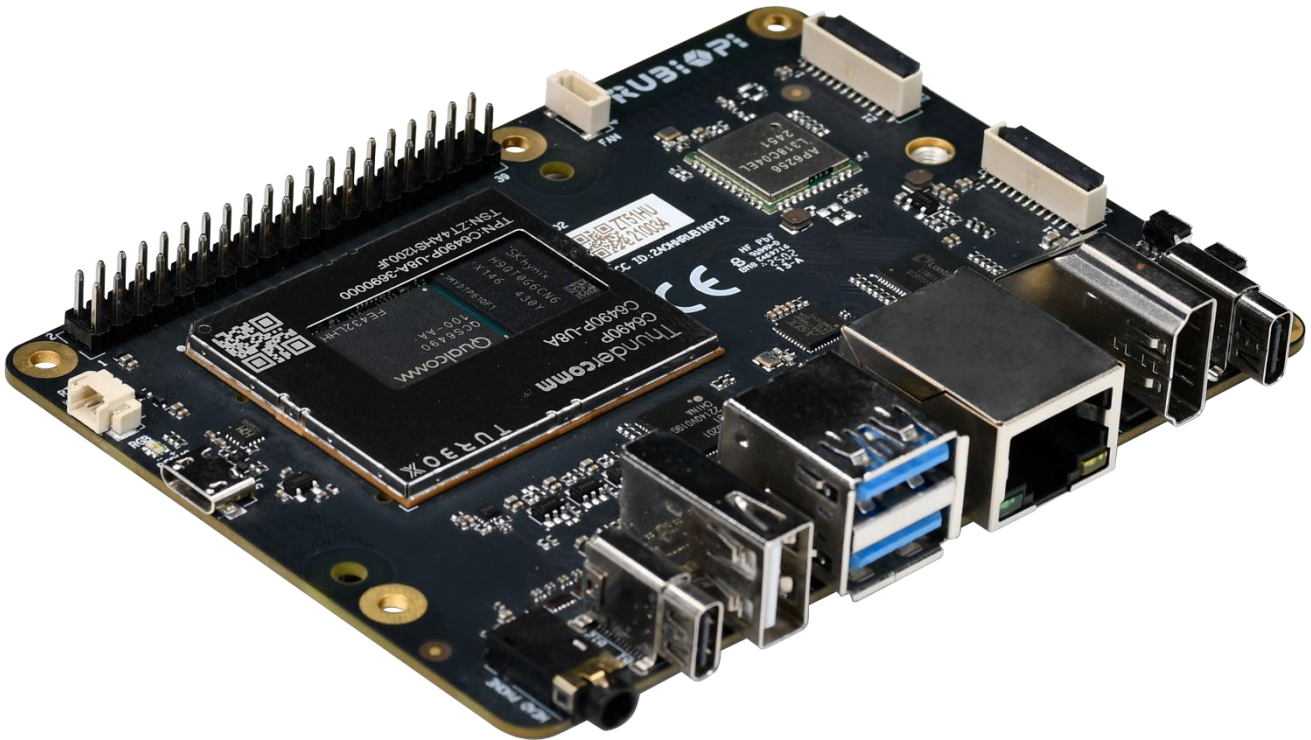

Category	RUBIK Pi 3 Feature
Platform	Qualcomm® QCS6490 RAM 8 GB LPDDR4x ROM 128 GB UFS2.2
Video	1 x HDMI 1.4 output (up to 4K 30 Hz) 1 x DP over USB Type-C (up to 4K 60 Hz) 2 x camera connector (4-lane MIPI CSI D-PHY)
Audio	1 x 3.5mm headphone jack
Connectivity	1 x USB Type-C (USB 3.1 Gen 1) 2 x USB Type-A (USB 3.0) 1 x USB Type-A (USB 2.0) 1 x 1000M Ethernet (RJ45) 1 x UART for debug (over Micro USB) 1 x M.2 Key M connector (PCIe3.0 2-lane) 40-pin LS connector supporting various interface options: <ul style="list-style-type: none"> • Up to 28 x GPIO • Up to 2 x I2C • Up to 3 x UART • Up to 3 x SPI • 1 x I2S (PCM) • 1 x PWM channel



Category	RUBIK Pi 3 Feature
Others	1 x PWR button 1 x EDL button 1 x RGB LED 2-pin RTC battery connector 4-pin PWM fan connector
Wireless Connection	Wi-Fi: IEEE 802.11 a/b/g/n/ac Wi-Fi Bluetooth: BT 5.2 On-board PCB antenna
Power Supply	Power Delivery over Type-C, 12V 3A
Operating Environment	Operating temperature: -20°C – 70°C
Dimensions	100mm x 75mm x 25mm
OS Support	Android 13 Qualcomm Linux Debian 12 *Canonical Ubuntu for Qualcomm platforms

*Planning

Chapter 2. Features

2.1. System block diagram

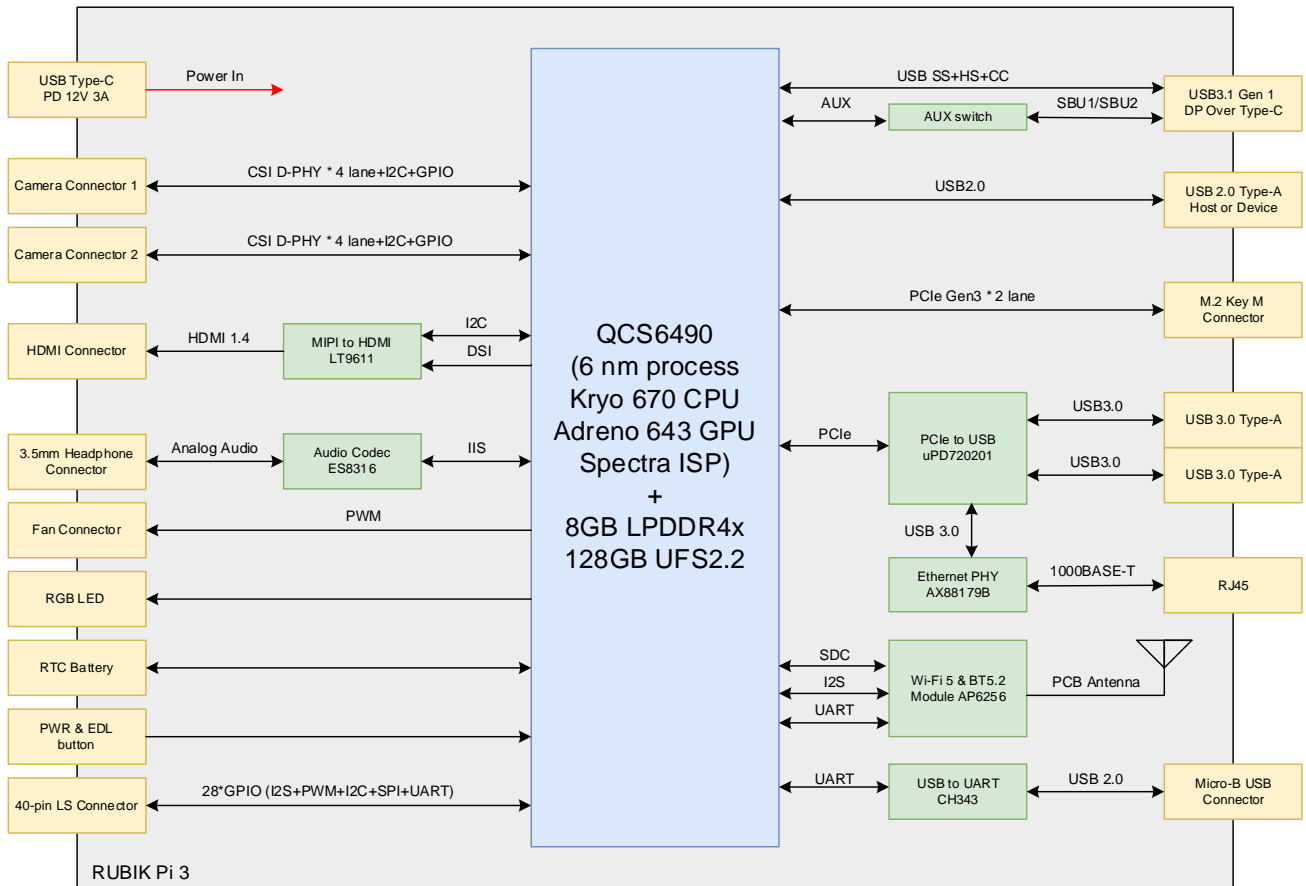

Figure 2-1. RUBIK Pi 3 System Block

2.2. Component locations

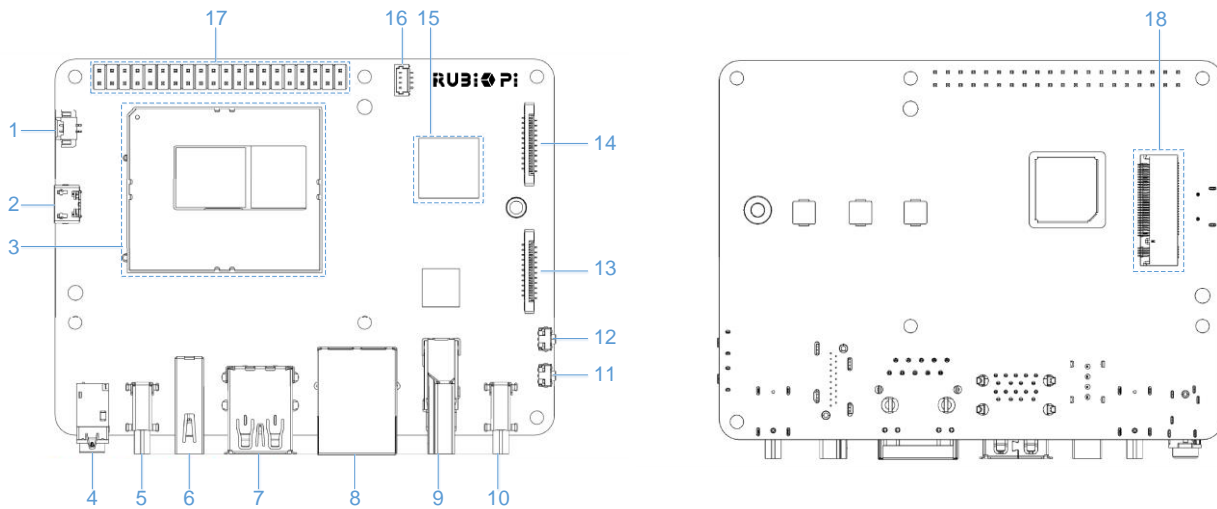

Figure 2-2. Locations of Major Components

Table 2-1. Interface list

No.	Interface	No.	Interface
1	RTC battery connector	10	Power Delivery over Type-C
2	Micro USB (UART debug)	11	PWR button
3	TurboX C6490P SOM	12	EDL button
4	3.5mm headphone jack	13	Camera connector 2
5	USB Type-C with DP (USB 3.1)	14	Camera connector 1
6	USB Type-A (USB 2.0)	15	Wi-Fi/BT module
7	2 x USB Type-A (USB 3.0)	16	Fan connector
8	1000M Ethernet	17	40-pin LS connector
9	HDMI OUT	18	M.2 Key M connector

2.3. Electrical characteristics

2.3.1. Power supply requirements

Rubik Pi 3 supports PD 3.0 power input. A Type-C 12V 3A power adapter compliant with PD3.0 is recommended for input power.

The power indicator LED (in yellow green) will turn on if the power adapter meets requirements and power negotiation succeeds. If the adapter does not meet requirements, the LED will remain off and the device will not boot.

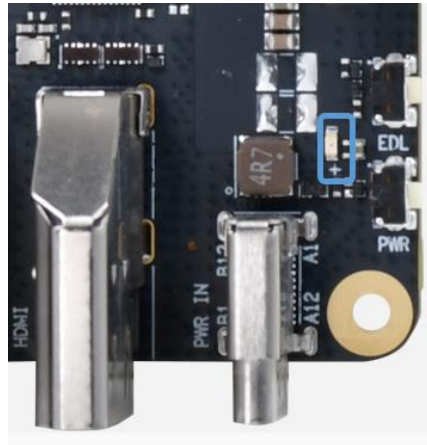

Figure 2-3. Power Indicator

2.3.2. Output power requirements

The following table lists the maximum current output from each connector with a 12V 3A power supply.

Table 2-2. Maximum current output from each connector

Connector	Output Voltage	Max. Output Current	Remarks
USB 3.0 Type-A - 1	5V	1.5A	The total current simultaneously output from the three USB ports cannot exceed 3A.
USB 3.0 Type-A - 2	5V	1.5A	
USB 2.0 Type-A	5V	1.5A	
40 Pin GPIO	5V	1A	
	3.3V	1A	
HDMI	5V	100mA	
M.2 Key M	3.3V	1A	
Camera 1	3.3V	300mA	
Camera 2	3.3V	300mA	

An output current exceeding the maximum threshold will trigger output power protection or a system restart.

It is not recommended to use the USB port of RUBIK Pi 3 to supply power to USB devices with high power consumption, such as USB fans, speakers, or displays.



2.4. Mechanical specification

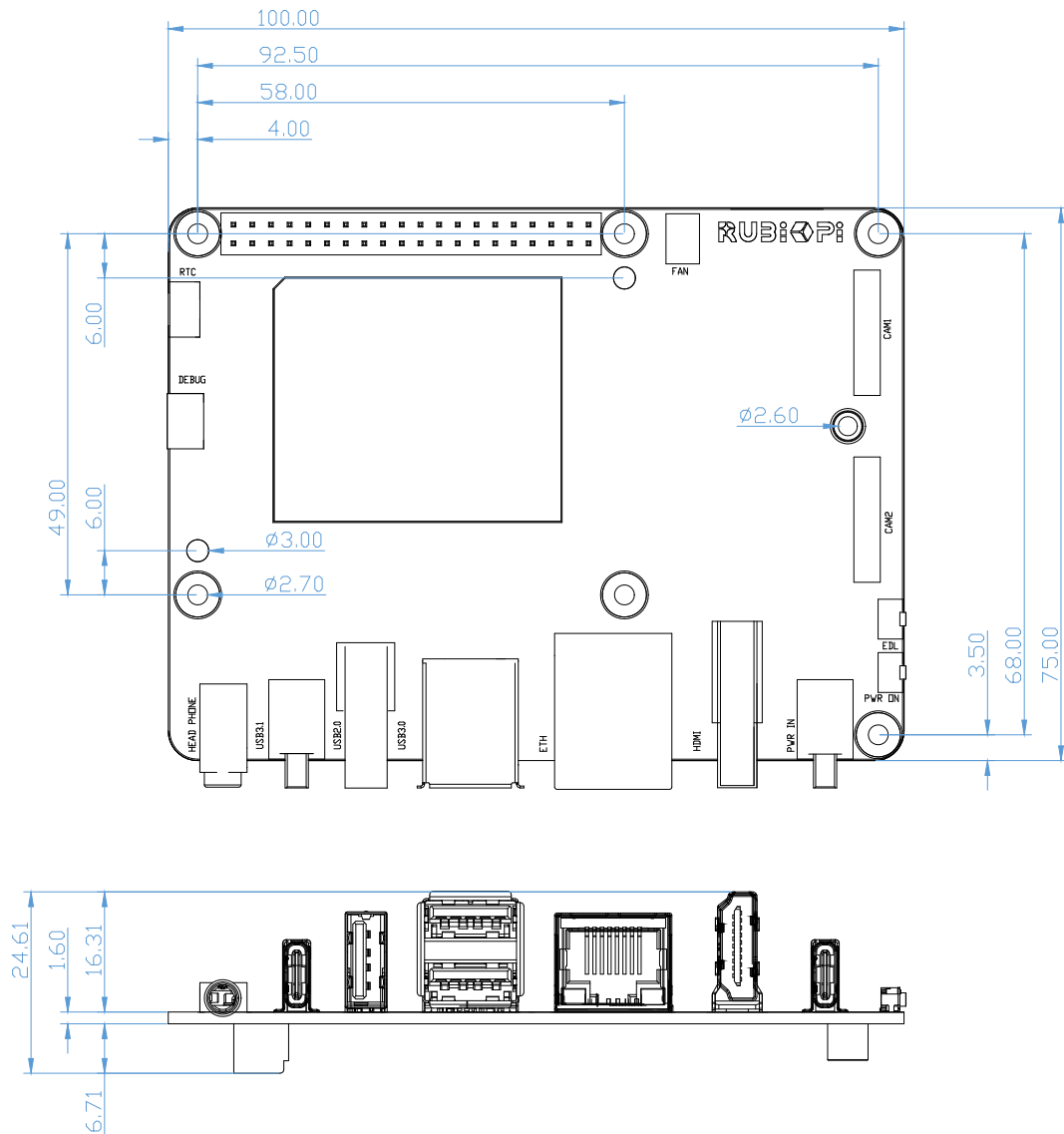

Figure 2-4. RUBIK Pi 3 Dimensions

*All dimensions are in millimeters.

Chapter 3. Expansion Connections

3.1. 40-pin LS connector

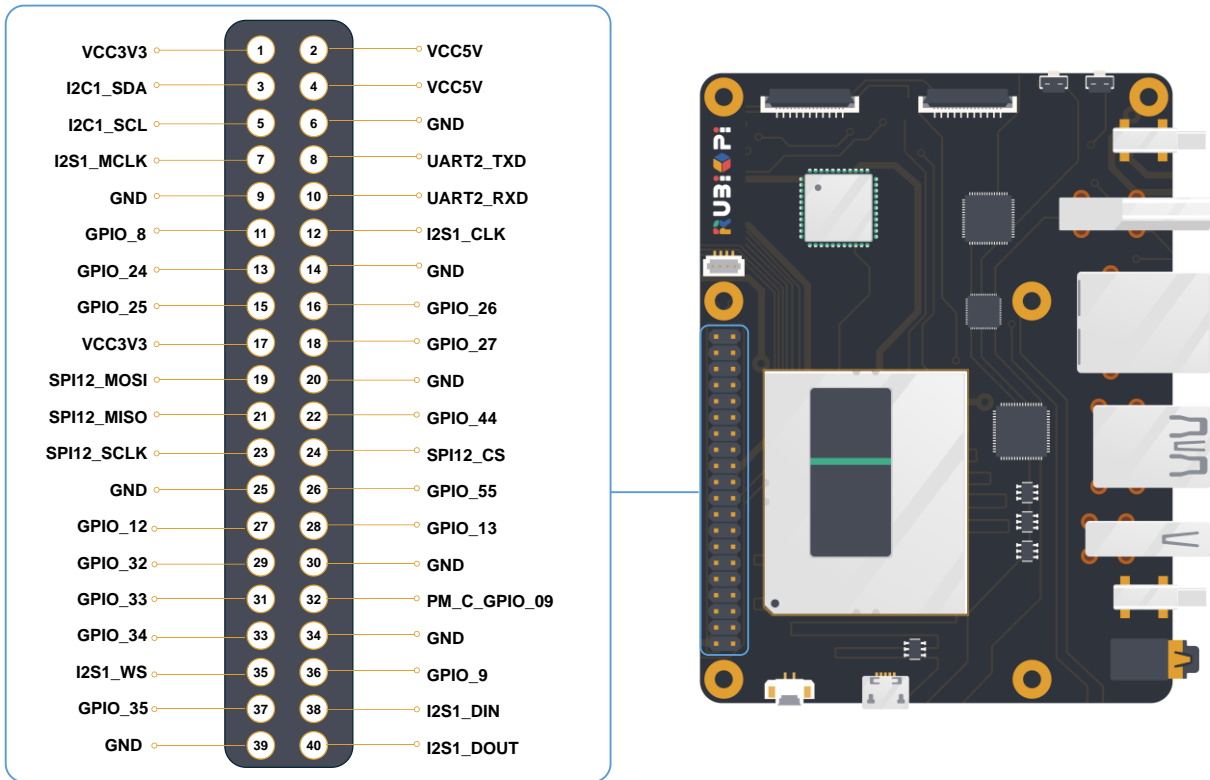

Figure 3-1. Default functions of the LS connector pins

Table 3-1. Pin definitions of the 40-pin LS connector

Fuction5	Fuction4	Fuction3	Fuction2	Fuction1	Pin#	Pin#	Fuction1	Fuction2	Fuction3	Fuction4	Fuction5	Fuction6
VCC3V3					1	2	VCC5V					
			I2C1_SDA	GPIO_4	3	4	VCC5V					
			I2C1_SCL	GPIO_5	5	6	GND					
I2S1_MCLK				GPIO_105	7	8	GPIO_10		SPI2_SCLK	UART2_TXD		
		GND			9	10	GPIO_11		SPI2_CS	UART2_RXD		
	UART2_CTS	SPI2_MISO	I2C2_SDA	GPIO_8	11	12	GPIO_101				I2S1_CLK	
	UART6_CTS	SPI6_MISO	I2C6_SDA	GPIO_24	13	14	GND					
	UART6_RTS	SPI6_MOSI	I2C6_SCL	GPIO_25	15	16	GPIO_26		SPI6_SCLK	UART6_TXD		
VCC3V3					17	18	GPIO_27		SPI6_CS	UART6_RXD		
	UART12_RTS	SPI12_MOSI	I2C12_SCL	GPIO_49	19	20	GND					
	UART12_CTS	SPI12_MISO	I2C12_SDA	GPIO_48	21	22	GPIO_44					
	UART12_TXD	SPI12_SCLK		GPIO_50	23	24	GPIO_51		SPI12_CS	UART12_RXD		
GND					25	26	GPIO_55					
			I2C3_SDA	GPIO_12	27	28	GPIO_13	I2C3_SCL				
	UART8_CTS	SPI8_MISO	I2C8_SDA	GPIO_32	29	30	GND					
	UART8_RTS	SPI8_MOSI	I2C8_SCL	GPIO_33	31	32	PM_C_GPIO_09					PWM
	UART8_TXD	SPI8_SCLK		GPIO_34	33	34	GND					
I2S1_WS				GPIO_103	35	36	GPIO_9	I2C2_SCL	SPI2_MOSI	UART2_RTS		
	UART8_RXD	SPI8_CS		GPIO_35	37	38	GPIO_102					I2S1_DIN
GND					39	40	GPIO_104					I2S1_DOUT

NOTE: Blue bold functions are default functions.

RUBIK Pi 3 provides 28 GPIOs. By default, 2 x I2C, 1 x UART, 1 x SPI, 1 x I2S, 1 x PWM IO, and 9 GPIOs are configured.

The level of all GPIOs is 3.3V. The I2C GPIOs (GPIO 4, 5, 12, 13) are in open-drain output mode with 4.7 k Ω pull-up resistors. The other GPIOs are in push-pull output mode, and the external pull-up or pull-down resistors of the connected signals cannot be less than 50 k Ω due to the limitations of the on-board level shifter IC.

The GPIOs belonging to the same QUP group can be flexibly configured as UART or SPI. For details, refer to the user manual.

The 2.54mm pitch 40-pin LS connector is compatible with the expansion boards of most open-source development boards.

3.2. HDMI connector

RUBIK Pi 3 comes with a standard-sized HDMI connector that is compatible with HDMI 1.4. This connector supports a maximum output of 4K 30 Hz. Additionally, it provides the CEC functionality, as well as 5V DDC and HPD interfaces.

3.3. Ethernet connector

RUBIK Pi 3 is equipped with a standard RJ45 connector that includes Link and Active indicator LEDs. This connector supports high-speed communication of up to 1000 Mbps in full duplex mode.

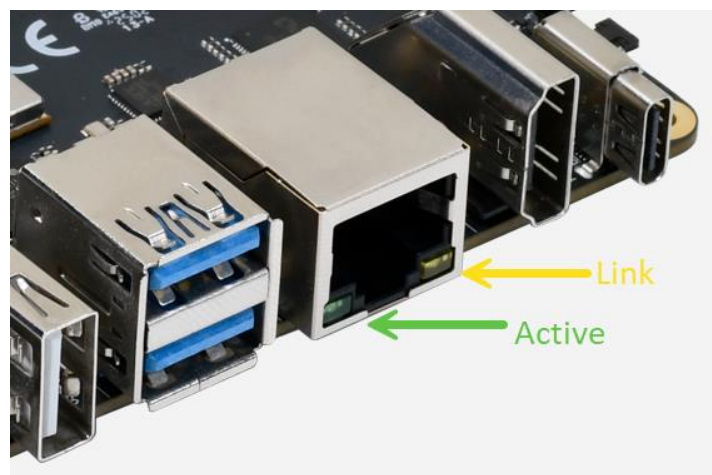

Figure 3-2. Link and Active Indicators

3.4. USB connector

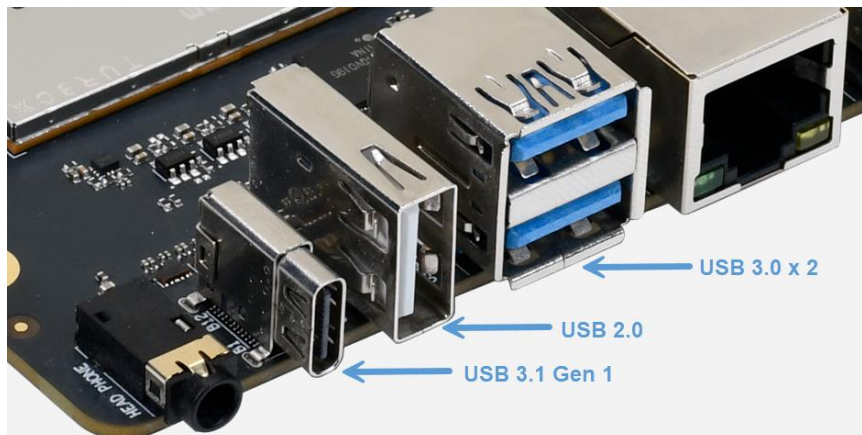

Figure 3-3. USB Ports

3.4.1. USB 3.1 Gen1 Type-C

RUBIK Pi 3 incorporates a USB 3.1 Gen1 Type-C port that supports Type-C with DisplayPort v1.4. The port allows for a maximum output of 4K 60 Hz when used with a Type-C to DP cable and supports read/write operations at speeds of up to 5 Gbps.

By default, this port is used for ADB debugging.

3.4.2. USB 3.0 Type-A

RUBIK Pi 3 features two standard USB 3.0 Type-A ports, each supporting read and write operations at speeds of up to 4 Gbps.

The USB 3.0 Type-A port can operate in host mode only. Each individual port has a maximum output capacity of 5V 1.5A. The power output of each port can be individually controlled.

3.4.3. USB 2.0 Type-A

RUBIK Pi 3 is equipped with a standard USB 2.0 Type-A port which supports read and write operations at speeds of up to 480 Mbps. This port works in host mode by default and can be switched to device mode and used as an ADB interface by using software. The maximum output capacity of this port is 5V 1.5A, while the total output of all three USB Type-A ports is 3A. The power output of this port can be individually controlled.

3.5. 3.5mm audio connector

The 3.5mm audio connector is designed according to CITA standard and supports left and right channels and microphone inputs.

The following figure shows the rings on the plug. From right to left, they are: 1-left channel, 2-right channel, 3-ground, 4-microphone.



Figure 3-4. Headphone Plug

Table 3-2. Pin definitions of the 3.5mm audio connector

Pin No.	Pin Name
1	Left
2	Right
3	GND
4	Mic

3.6. Camera connector



Figure 3-5. Camera Connectors

RUBIK Pi 3 provides two 22-pin camera connectors. Each connector supports 4-lane MIPI CSI D-PHY and provides one I2C and two control GPIOs. The GPIO level is 3.3V, where the I2C signal is in open-drain mode with pull-up resistors. The pitch of the connector is 0.5mm and the connector is pin-to-pin compatible with Raspberry Pi 5 cameras.



Drivers of the following cameras are integrated:

- Raspberry Pi HQ Camera (IMX 477)
- Raspberry Pi Camera Module 2 (IMX 219)
- Raspberry Pi Camera Module 3 (IMX 708)

Table 3-3. Pin definitions of the camera connectors

Camera Connector 1		Camera Connector 2	
Pin Name	Pin No.	Pin No.	Pin Name
GND	1	1	GND
CSI0_LN0_M	2	2	CSI1_LN0_M
CSI0_LN0_P	3	3	CSI1_LN0_P
GND	4	4	GND
CSI0_LN1_M	5	5	CSI1_LN1_M
CSI0_LN1_P	6	6	CSI1_LN1_P
GND	7	7	GND
CSI0_CLK_M	8	8	CSI1_CLK_M
CSI0_CLK_P	9	9	CSI1_CLK_P
GND	10	10	GND
CSI0_LN2_M	11	11	CSI1_LN2_M
CSI0_LN2_P	12	12	CSI1_LN2_P
GND	13	13	GND
CSI0_LN3_M	14	14	CSI1_LN3_M
CSI0_LN3_P	15	15	CSI1_LN3_P
GND	16	16	GND
CAMERA1_PWR_EN(GPIO_57)	17	17	CAMERA2_PWR_EN(GPIO_58)
CAMERA1_GPIO(GPIO_18)	18	18	CAMERA2_GPIO(GPIO_19)
GND	19	19	GND
CAMERA1_I2C_SCL(GPIO_74)	20	20	CAMERA2_I2C_SCL(GPIO_70)
CAMERA1_I2C_SDA(GPIO_73)	21	21	CAMERA2_I2C_SDA(GPIO_69)
VCC3V3_OUT	22	22	VCC3V3_OUT

3.7. M.2 connector

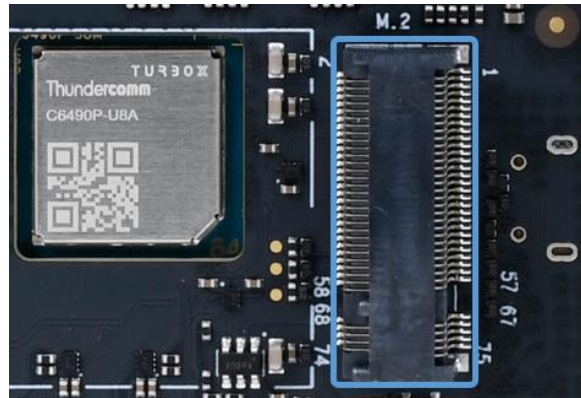

Figure 3-6. M.2 Connector

RUBIK Pi 3 provides an M.2 slot for NVMe storage, which can be used to install 2280-sized SSD hard drives. The M.2 Key M slot supports PCIe Gen3 x2 and can deliver an output of up to 3.3V 2A. The switch of the M.2 connector can be individually controlled.

Table 3-4. Pin definitions of the M.2 connector

Pin Name	Pin No.	Pin No.	Pin Name
GND	1	2	VCC3V3_OUT
GND	3	4	VCC3V3_OUT
NC	5	6	NC
NC	7	8	NC
GND	9	10	NC
NC	11	12	VCC3V3_OUT
NC	13	14	VCC3V3_OUT
GND	15	16	VCC3V3_OUT
NC	17	18	VCC3V3_OUT
NC	19	20	NC
GND	21	22	NC
NC	23	24	NC
NC	25	26	NC
GND	27	28	NC
PCIE1_RX1_M	29	30	NC
PCIE1_RX1_P	31	32	NC



Pin Name	Pin No.	Pin No.	Pin Name
GND	33	34	NC
PCIE1_TX1_M	35	36	NC
PCIE1_TX1_P	37	38	NC
GND	39	40	NC
PCIE1_RX0_M	41	42	NC
PCIE1_RX0_P	43	44	NC
GND	45	46	NC
PCIE1_TX0_M	47	48	NC
PCIE1_TX0_P	49	50	PCIE_RESET_N ⁽¹⁾
GND	51	52	PCIE_CLK_REQ_N ⁽¹⁾
PCIE1_REFCLK_M	53	54	PCIE_WAKE_N ⁽¹⁾
PCIE1_REFCLK_P	55	56	NC
GND	57	58	NC
...
NC	67	68	NC
NC	69	70	VCC3V3_OUT
GND	71	72	VCC3V3_OUT
GND	73	74	VCC3V3_OUT
GND	75		

(1). The level of the PCIe control IOs is 3.3V.

3.8. Wi-Fi

RUBIK Pi 3 integrates the on-board wireless communication module that supports IEEE 802.11 a/b/g/n/ac Wi-Fi. The on-board PCB antenna is provided, eliminating the need for additional antennas.

3.9. Bluetooth

The on-board wireless communication module of RUBIK Pi 3 also provides the BT5.2 function for Bluetooth data transfer and Bluetooth audio applications. The Bluetooth shares the PCB antenna with Wi-Fi, eliminating the need for additional antennas.

3.10. Fan connector



Figure 3-7. Fan Connector

The fan connector of RUBIK Pi 3 is a 4-pin 1mm pitch connector which is suitable for 5V fans whose maximum rated current is smaller than 200 mA. Its pin definition and board mounting holes are compatible with the official Raspberry Pi 5 fan. The fan connector supports PWM control.

Table 3-5. Pin definitions of the fan connector

Pin No.	Pin Name
1	NC
2	GND
3	PWM_OUT ⁽¹⁾
4	VCC5V_OUT

(1). The level of PWM_OUT is 5V.

3.11. RTC battery connector

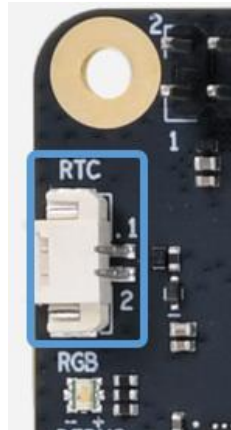

Figure 3-8. RTC Battery Connector

RUBIK Pi 3 includes a 2-pin 1.25mm pitch RTC battery connector, compatible only with 3V coin cell batteries. The voltage range for normal operation is 2V – 3.25V.

Table 3-6. Pin definitions of the RTC battery connector

Pin No.	Pin Name
1	VCC3V_IN
2	GND

3.12. Micro USB to UART for debug

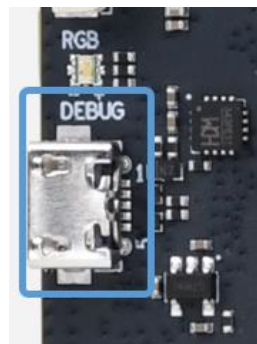

Figure 3-9. Micro USB

RUBIK Pi 3 incorporates the CH343, a USB to UART TTL bridge IC made by WinChipHead (WCH). UART logs from the SoC can be obtained through connecting the device to a computer via micro USB.

The default UART setting is 115200 baud rate, 8 data bits, 1 stop bit, and no parity.

Download the CH343 driver at the official website: [Driver](#).

3.13. Buttons

3.13.1. Power on button

Plug in the power supply and press the **[PWR]** button once to boot up the device. If the indicator light flashes once, it indicates that the device has powered on successfully and is starting to operate.

3.13.2. EDL button

The EDL button stands for Emergency Download (EDL) button. Plug in the power supply. Press and hold both the **[PWR]** button and **[EDL]** button for more than 3s to make the device enter EDL mode (9008).

3.14. LED

3.14.1. Power indicator LED

The indicator LED lights steadily in yellow-green when a compliant (12V 3A, PD-supported) power supply is connected, indicating that the device is ready.

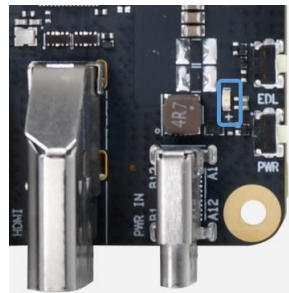

Figure 3-10. Power Indicator LED

3.14.2. RGB LED

RUBIK Pi 3 is equipped with an on-board RGB LED that supports PWM dimming.



Figure 3-11. RGB LED



Chapter 4. Precautions

4.1. Operating environment

The ambient operating temperature range for RUBIK Pi 3 is $-20^{\circ}\text{C} - 70^{\circ}\text{C}$. While using RUBIK Pi 3, please closely monitor the CPU temperature and take appropriate cooling measures to ensure it stays below 85°C . This will help prevent issues like performance degradation or throttling that could negatively affect the user experience.

4.2. ESD prevention

Prevent electrostatic discharge (ESD) and avoid touching any components on the board under any circumstances.

4.3. Warning

Any external power supply used with RUBIK Pi 3 must comply with the relevant regulations and standards of the country in which it is used. The power supply should provide 12V DC and a minimum rated current of 3A.

4.4. Safety instructions

- This product should not be overclocked.
- Do not operate this product in water or humid environments.
- Do not place this product on conductive surfaces.
- Keep this product away from heat sources. It is designed for use at normal room temperature to ensure reliable operation.
- Do not expose the circuit board to high-intensity light sources, such as xenon flashlights or lasers.
- Operate this product in a well-ventilated environment, and do not cover it during use.
- Place this product on a stable, flat, and insulated surface and avoid contact with conductive materials.
- Handle this product carefully to prevent mechanical or electrical damage to the printed circuit board and connectors.
- Avoid touching or handling the product when it is powered on. Only touch the edges of the product to minimize the risk of electrostatic discharge damage.
- Any peripherals or devices used with RUBIK Pi 3 must comply with the relevant standards of the country in which it is used and be appropriately marked to ensure safety and performance requirements are met.



Appendix 1. Compliance and Certificate Information

FCC statements:

Caution!

Any changes or modifications not expressly approved by the party responsible for compliance could void the user's authority to operate the equipment.

This device complies with FCC radiation exposure limits set forth for an uncontrolled environment and it also complies with Part 15 of the FCC RF Rules. This equipment must be installed and operated in accordance with provided instructions and the antenna(s) used for this transmitter must be installed to provide a separation distance of at least 20 cm from all persons and must not be co-located or operating in conjunction with any other antenna or transmitter. End-users and installers must be provided with antenna installation instructions and consider removing the no-collocation statement.

This device complies with Part 15 of the FCC Rules. Operation is subject to the following two conditions:

- (1) This device may not cause harmful interference.
- (2) This device must accept any interference received, including interference that may cause undesired operation.

NOTE: This equipment has been tested and found to comply with the limits for a Class B digital device, pursuant to Part 15 of the FCC Rules. These limits are designed to provide reasonable protection against harmful interference in a residential installation. This equipment generates and can radiate radio frequency energy and, if not installed and used in accordance with the instructions, may cause harmful interference to radio communications. However, there is no guarantee that interference will not occur in a particular installation. If this equipment does cause harmful interference to radio or television reception, which can be determined by turning the equipment off and on, the user is encouraged to try to correct the interference by one or more of the following measures:

- Reorient or relocate the receiving antenna.
- Increase the separation between the equipment and receiver.
- Connect the equipment to an outlet on a circuit different from that to which the receiver is connected.
- Consult the dealer or an experienced radio/TV technician for help.

OEM INTEGRATION INSTRUCTIONS:

This device is intended only for OEM integrators under the following conditions:

The module must be installed in the host equipment such that 20 cm is maintained between the antenna and users, and the transmitter module may not be co-located with any other transmitter or



antenna. The module shall be only used with the internal on-board antenna that has been originally tested and certified with this module. External antennas are not supported. As long as these 3 conditions above are met, further transmitter tests will not be required.

However, the OEM integrator is still responsible for testing their end product for any additional compliance requirements required with this module installed (for example, digital device emissions, PC peripheral requirements, etc.). The end product may need Verification testing, Declaration of Conformity testing, a Permissive Class II Change, or new Certification. Please involve an FCC certification specialist in order to determine what will be exactly applicable to the end product.

Validity of using the module certification:

In the event that these conditions cannot be met (for example certain laptop configurations or co-location with another transmitter), then the FCC authorization for this module in combination with the host equipment is no longer considered valid and the FCC ID of the module cannot be used on the final product. In these circumstances, the OEM integrator will be responsible for re-evaluating the end product (including the transmitter) and obtaining a separate FCC authorization. In such cases, please involve an FCC certification specialist in order to determine if a Permissive Class II Change or new Certification is required.

Upgrade Firmware:

The software provided for firmware upgrade will not be capable of affecting any RF parameters as certified for the FCC for this module, in order to prevent compliance issues.

End product labeling:

This transmitter module is authorized only for use in devices where the antenna may be installed such that 20 cm may be maintained between the antenna and users. The final end product must be labeled in a visible area with the following: "Contains FCC ID: 2AOHHRUBIKPI3".

The OEM integrator has to be aware not to provide information to the end user regarding how to install or remove this RF module in the user's manual of the end product that integrates this module. The end user manual shall include all required regulatory information/warning as shown in this manual.

CAUTION: Exposure to Radio Frequency Radiation.

The antenna shall be mounted in such a manner to minimize the potential for human contact during normal operation. The antenna should not be contacted during operation to avoid the possibility of exceeding the FCC radio frequency exposure limit.

Requirement per KDB996369 D03



2.2 List of applicable FCC rules

List the FCC rules that are applicable to the modular transmitter. These are the rules that specifically establish the bands of operation, the power, spurious emissions, and operating fundamental frequencies. DO NOT list compliance to unintentional-radiator rules (Part 15 Subpart B) since that is not a condition of a module grant that is extended to a host manufacturer. See also Section 2.10 below concerning the need to notify host manufacturers that further testing is required.³

Explanation: This module meets the requirements of FCC part 15C(15.247). part 15E(15.407)

2.3 Summarize the specific operational use conditions

Describe use conditions that are applicable to the modular transmitter, including for example any limits on antennas, etc. For example, if point-to-point antennas are used that require reduction in power or compensation for cable loss, then this information must be in the instructions. If the use condition limitations extend to professional users, then instructions must state that this information also extends to the host manufacturer's instruction manual. In addition, certain information may also be needed, such as peak gain per frequency band and minimum gain, specifically for master devices in 5 GHz DFS bands.

Explanation: The EUT has a PCBA antenna, and the antenna uses a permanently attached antenna which is not replaceable.

2.4 Limited module procedures

If a modular transmitter is approved as a "limited module", then the module manufacturer is responsible for approving the host environment that the limited module is used with. The manufacturer of a limited module must describe, both in the filing and in the installation instructions, the alternative means that the limited module manufacturer uses to verify that the host meets the necessary requirements to satisfy the module limiting conditions.

A limited module manufacturer has the flexibility to define its alternative method to address the conditions that limit the initial approval, such as shielding, minimum signaling amplitude, buffered modulation/data inputs, or power supply regulation. The alternative method could include that the limited module manufacturer reviews detailed test data or host designs prior to giving the host manufacturer approval.

This limited module procedure is also applicable for RF exposure evaluation when it is necessary to demonstrate compliance in a specific host. The module manufacturer must state how control of the product into which the modular transmitter will be installed will be maintained such that full compliance of the product is always ensured. For additional hosts other than the specific host originally granted with a limited module, a Class II permissive change is required on the module grant to register the additional host as a specific host also approved with the module.

Explanation: The module is not a limited module.



2.5 Trace antenna designs

For a modular transmitter with trace antenna designs, see the guidance in Question 11 of KDB Publication 996369 D02 FAQ – Modules for Micro-Strip Antennas and traces. The integration information shall include for the TCB review the integration instructions for the following aspects:

Layout of trace design, parts list (BOM), antenna, connectors, and isolation requirements.

- a) Information that includes permitted variances (e.g., trace boundary limits, thickness, length, width, shape(s), dielectric constant, and impedance as applicable for each type of antenna);
- b) Each design shall be considered a different type (e.g., antenna length in multiple(s) of frequency, the wavelength, and antenna shape (traces in phase) can affect antenna gain and must be considered);
- c) The parameters shall be provided in a manner permitting host manufacturers to design the printed circuit (PC) board layout;
- d) Appropriate parts by manufacturer and specifications;
- e) Test procedures for design verification; and
- f) Production test procedures for ensuring compliance.

The module grantee shall provide a notice that any deviation(s) from the defined parameters of the antenna trace, as described by the instructions, require that the host product manufacturer must notify the module grantee that they wish to change the antenna trace design. In this case, a Class II permissive change application is required to be filed by the grantee, or the host manufacturer can take responsibility through the change in FCC ID (new application) procedure followed by a Class II permissive change application.

Explanation: Yes, the module has trace antenna designs, and this manual has shown the layout of trace design, antenna, connectors, and isolation requirements.

2.6 RF exposure considerations

It is essential for module grantees to clearly and explicitly state the RF exposure conditions that permit a host product manufacturer to use the module. Two types of instructions are required for RF exposure information: (1) to the host product manufacturer, to define the application conditions (mobile, portable – xx cm from a person's body); and (2) additional text needed for the host product manufacturer to provide to end users in their end-product manuals. If RF exposure statements and use conditions are not provided, then the host product manufacturer is required to take responsibility for the module through a change in FCC ID (new application).

Explanation: This module complies with FCC RF radiation exposure limits set forth for an uncontrolled environment. This equipment should be installed and operated with a minimum distance of 20 centimeters between the radiator and your body. This module is designed to comply with the FCC statement, FCC ID is: 2AOHHRUBIKPI3.



2.7 Antennas

A list of antennas included in the application for certification must be provided in the instructions. For modular transmitters approved as limited modules, all applicable professional installer instructions must be included as part of the information to the host product manufacturer. The antenna list shall also identify the antenna types (monopole, PIFA, dipole, etc. (note that for example an "omni-directional antenna" is not considered to be a specific "antenna type")).

For situations where the host product manufacturer is responsible for an external connector, for example with an RF pin and antenna trace design, the integration instructions shall inform the installer that a unique antenna connector must be used on the Part 15 authorized transmitters used in the host product. The module manufacturers shall provide a list of acceptable unique connectors.

Explanation: The EUT has a Chip Antenna, and the antenna uses a permanently attached antenna which is unique.

2.8 Label and compliance information

Grantees are responsible for the continued compliance of their modules to the FCC rules. This includes advising host product manufacturers that they need to provide a physical or e-label stating "Contains FCC ID" with their finished product. See Guidelines for Labeling and User Information for RF Devices – KDB Publication 784748.

Explanation: The host system using this module, should have a label in a visible area indicating the following text: "Contains FCC ID: 2AOHHRUBIKPI3"

2.9 Information on test modes and additional testing requirements

Additional guidance for testing host products is given in KDB Publication 996369 D04 Module Integration Guide. Test modes should take into consideration different operational conditions for a stand-alone modular transmitter in a host, as well as for multiple simultaneously transmitting modules or other transmitters in a host product.

The grantee should provide information on how to configure test modes for host product evaluation for different operational conditions for a stand-alone modular transmitter in a host, versus with multiple, simultaneously transmitting modules or other transmitters in a host.

Grantees can increase the utility of their modular transmitters by providing special means, modes, or instructions that simulate or characterize a connection by enabling a transmitter. This can greatly simplify a host manufacturer's determination that a module as installed in a host complies with FCC requirements.

Explanation: The top band can increase the utility of our modular transmitters by providing instructions that simulate or characterize a connection by enabling a transmitter.

2.10 Additional testing, Part 15 Subpart B disclaimer

The grantee should include a statement that the modular transmitter is only FCC-authorized for the specific rule parts (i.e., FCC transmitter rules) listed on the grant, and that the host product



manufacturer is responsible for compliance with any other FCC rules that apply to the host not covered by the modular transmitter grant of certification. If the grantee markets their product as being Part 15 Subpart B compliant (when it also contains unintentional-radiator digital circuitry), then the grantee shall provide a notice stating that the final host product still requires Part 15 Subpart B compliance testing with the modular transmitter installed.

Explanation: The module does not include unintentional-radiator digital circuitry, so the module does not require an evaluation by FCC Part 15 Subpart B. The host should be evaluated by the FCC Subpart B.

IC statements:

This device contains licence-exempt transmitter(s)/receiver(s) that comply with Innovation, Science and Economic Development Canada's licence-exempt RSS(s). Operation is subject to the following two conditions:

- (1) This device may not cause interference.
- (2) This device must accept any interference, including interference that may cause undesired operation of the device.

L'émetteur/récepteur exempt de licence contenu dans le présent appareil est conforme aux CNR d'Innovation, Sciences et Développement économique Canada applicables aux appareils radio exempts de licence. L'exploitation est autorisée aux deux conditions suivantes:

- (1) L'appareil ne doit pas produire de brouillage;
- (2) L'appareil doit accepter tout brouillage radioélectrique subi, même si le brouillage est susceptible d'en compromettre le fonctionnement.

The device meets the exemption from the routine evaluation limits in section 2.5 of RSS 102 and compliance with RSS-102 RF exposure, users can obtain Canadian information on RF exposure and compliance.

Le dispositif rencontre l'exemption des limites courantes d'évaluation dans la section 2.5 de RSS 102 et la conformité à l'exposition de RSS-102 rf, utilisateurs peut obtenir l'information canadienne sur l'exposition et la conformité de rf.

the device for operation in the band 5150-5250 MHz is only for indoor use to reduce the potential for harmful interference to co-channel mobile satellite systems

les dispositifs fonctionnant dans la bande 5150-5250 MHz sont réservés uniquement pour une utilisation à l'intérieur afin de réduire les risques de brouillage préjudiciable aux systèmes de satellites mobiles utilisant les mêmes canaux;

1. the device for operation in the band 5150–5250 MHz is only for indoor use to reduce the potential for harmful interference to co-channel mobile satellite systems;
2. for devices with detachable antenna(s), the maximum antenna gain permitted for devices in the bands 5250-5350 MHz and 5470-5725 MHz shall be such that the equipment still complies with the e.i.r.p. limit;



3. for devices with detachable antenna(s), the maximum antenna gain permitted for devices in the band 5725-5850 MHz shall be such that the equipment still complies with the e.i.r.p. limits specified for point-to-point and non-point-to-point operation as appropriate.
1. les dispositifs fonctionnant dans la bande 5150-5250 MHz sont réservés uniquement pour une utilisation à l'intérieur afin de réduire les risques de brouillage préjudiciable aux systèmes de satellites mobiles utilisant les mêmes canaux;
2. le gain maximal d'antenne permis pour les dispositifs utilisant les bandes 5250-5350 MHz et 5470-5725 MHz doit se conformer à la limite de p.i.r.e.;
3. le gain maximal d'antenne permis (pour les dispositifs utilisant la bande 5725-5850 MHz) doit se conformer à la limite de p.i.r.e. spécifiée pour l'exploitation point à point et non point à point, selon le cas.

Caution!

Any changes or modifications not expressly approved by the party responsible for compliance could void the user's authority to operate the equipment.

CE statements:

Do not use the module in the environment at too high or too low temperature, never expose the module under strong sunshine or too wet environment.

RF exposure information: The Maximum Permissible Exposure (MPE) level has been calculated based on a distance of $d=20$ cm between the device and the human body. To maintain compliance with RF exposure requirement, use product that maintain a 20cm distance between the device and human body.

EU Regulatory Conformance

Hereby we,

Name of manufacturer: Thundercomm Technology Co., Ltd

Address: No. 107, Middle Datagu Road, Xiantao Street, Yubei District, Chongqing, China, 401122

declare that this DoC is issued under our sole responsibility and that this product:

Product description: Rubik Pi

Type designation(s): RUBIK Pi 3, RUBIK Pi 3 Lite

Trademark: Rubik Pi

Object of the declaration: [Model: RUBIK Pi 3, RUBIK Pi 3 Lite, The device is Rubik Pi, it supports 2.4G WiFi, 5G WiFi, BT functions. For more details, please refer to the user manual.]

is in conformity with the relevant Union harmonization legislation:

**Radio Equipment Directive 2014/53/EU:**

with reference to the following standards applied:

Safety	IEC 62368-1: 2018
	EN IEC 62368-1: 2020+A11: 2020
Electromagnetic compatibility	ETSI EN 301 489-1 V2.2.3(2019-11)
	Draft ETSI EN 301 489-17 V3.2.6 (2023-06)
	EN 55032: 2015+A1:2020
	EN 55035: 2017+A11:2020
	EN IEC 61000-3-2: 2019+A2:2024
	EN 61000-3-3: 2013+A2:2021
Radio frequency spectrum usage	ETSI EN 300 328 V2.2.2(2019-07); ETSI EN 300 328 V2.2.2(2019-07); ETSI EN 301 893 V2.2.1(2017-05); ETSI EN 300 440 V2.2.1(2018-07)
Health	EN IEC 62311: 2020; EN 50665:2017
Article 3.3.g emergency services access	N/A

The Notified Body Kiwa Nederland B.V. , with Notified Body number 0063 performed:

Applicable Modules: B+C

Where applicable:The issued EU-type examination certificate: NA**Accessories:**

Software version: LE 1.0 (Note: Some software updates will be released by the manufacturer to fix some bug or enhance some function after placing on the market. All versions released by the manufacturer have been verified and still compliance with the related rules. All RF parameters (e.g.: frequency range, output power) are not accessible to the user, and can't be changed by the user.)

Signed for and on behalf of:

March 26, 2025 China

shaolei.ke Project Manager

Place and date of issue

Name, Function, signature

The device for operation in the band 5150–5350 MHz is only for indoor use to reduce the potential for harmful interference to co-channel mobile satellite systems.



	AT	BE	BG	CH	CY	CY	DE	DK
	EE	EL	ES	FI	FR	HR	HU	IE
	IS	IT	LI	LT	LU	LV	MT	NL
	PL	PT	RO	SE	SI	SK	TR	UK(NI)

Frequency bands and power

Radio	Operation Frequency	Max. Output Power
Bluetooth	2402-2480 MHz	5.74 dBm
2.4G Wi-Fi	2412-2472 MHz	17.37 dBm
5G Wi-Fi	5.150-5.250 GHz	17.22 dBm
	5.250-5.350 GHz	17.01 dBm
	5.470-5.725 GHz	17.27 dBm
	5.725-5.825 GHz	13.02 dBm

Manufacturer: Thundercomm Technology Co., Ltd

Manufacturer Address: No. 107, Middle Datagu Road, Xiantao Street, Yubei District, Chongqing, China, 401122.